

Regency City Series

INSPIRING FRESH SPACES.
A DESIGNER'S DREAM.

 **REGENCY**[®]
FIREPLACE PRODUCTS

Regency City Series

LINEAR FAMILY



NEW YORK VIEW 40"
NEW YORK VIEW 72"

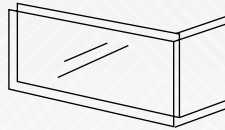

CHICAGO CORNER LEFT 40"
CHICAGO CORNER RIGHT 40"

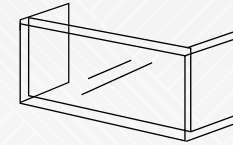

SAN FRANCISCO BAY 40"



QUALITY PRODUCT WITH FUNCTION AND BEAUTY

With over 35 years of innovation and quality, Regency designers are introducing the most cutting edge contemporary design.

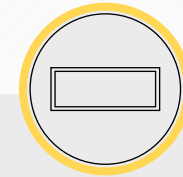

UNLIMITED FINISHING OPTIONS

The clean face design does not require frames or faceplates so you can enjoy the look of a modern clear view fire.

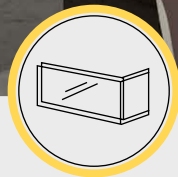

SEAMLESS GLASS SAFETY BARRIER

The double layered glass safety barrier allows air to flow naturally between the two layers of glass maintaining a low enough temperature to comply with industry standards. *(Patent Pending)*



COOL TOUCH WALL TECHNOLOGY

Maintain a cool wall around your fireplace to accommodate any finishing application such as wallpaper, fabric and even wood! *(Patent Pending)*



New York View 40 shown with volcanic stones & reflective black glass interior panels.

New York View

AVAILABLE IN SIZES 40" & 72"

The front facing linear fireplace can be strikingly integrated into any room.



New York View 72 shown with black reflective crystals, crushed coal black glass & reflective black enamel interior panels.

Infinite
Combinations.

Design Freedom.





New York View 72 shown with black reflective crystals, crushed coal black glass & reflective black enamel interior panels.



Chicago Right Corner 40 shown with black reflective crystals, crushed coal black glass & reflective enamel panels.

Chicago Corner

AVAILABLE AS LEFT OR RIGHT CORNER IN SIZE 40"

The 2-sided corner fireplace allows you to have design flexibility from any side of the room.



Chicago Left Corner 40 shown with black reflective crystals, crushed coal black glass & reflective enamel panels.



San Francisco Bay 40 shown with crushed coal black glass, volcanic stones & black glass interior panels.

San Francisco Bay

AVAILABLE IN SIZE 40"

The 3-sided bay fireplace creates a focal point that shows off the fire from multiple angles in the room.

*San Francisco Bay 40 shown with crushed coal black glass, driftwood logs & black glass interior panels.
Installed using framing kit, Sonoma Oak finishing panels & black glass hearth top.*

Free The
Imagination.

Create Unique Spaces.





*New York View 72 shown with black reflective crystals, crushed coal
black glass & reflective black enamel interior panels.*

OPTIONS

FIREBED OPTIONS



Driftwood Log Set



Volcanic Stones



Starfire Crystals & Iceberg Crushed Glass



Reflective Black Crystals & Black Coal Crushed Glass

INTERIOR OPTIONS



Black Steel Panels



Premium Reflective
Black Glass Panels

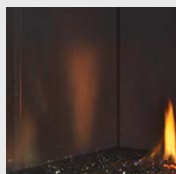

Reflective Black
Enamel Panels

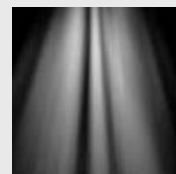

Accent Lights
(Standard)

READY TO INSTALL FRAMING KITS & FINISHING PANELS



The Regency City Series finishing panels and framing kits give you the ability to create a designer space in a few easy steps. No designer or external contractors required. For more framing kit configurations visit regency-fire.com.

1



Locate your fireplace and assemble the steel framing kit

2



Choose from a variety of engineered finishing panels

3



Attach your easy to install finishing panels
(Shown in Sonoma Oak)

FINISHES



Dark Loft

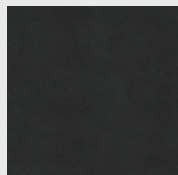

Iron Grey
Leather



Loft



Sonoma Oak

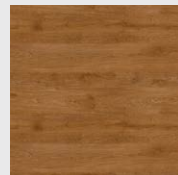

Vintage Oak

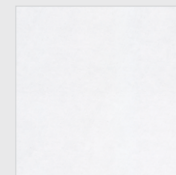

White Leather

COMBUSTIBLE FRAMING TO GLASS. NO RESTRICTIONS.



Maintain a cool wall specifically designed to accommodate custom finishes right to the edge of your fireplace! Regency's patent pending system allows the wall to release the excess heat from the chase to maintain a lower heat temperature.

ADVANTAGES

- Place a TV above the fireplace without the screen cracking or electrical components getting damaged
- Hang artwork without fear of discoloration or warping
- Unlimited finishing options right to the edge, even wood or wallpaper
- Paint will not peel or change color
- Save on expensive installation costs
- No fans or power-vents required to keep the wall cool



Wood



Wallpaper

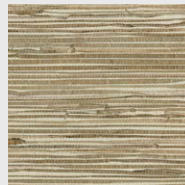

Fabric



Glass

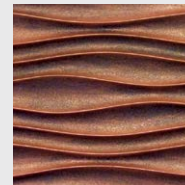

Textured Panel

BUILD YOUR OWN CUSTOM FIREPLACE



The Regency City Series gives you the freedom to install into a wood frame or choose from one of our telescoping steel framing kits. The Regency engineered steel framing kits give you the ease of installation while still enabling you to be the designer.

WOOD FRAMING



REGENCY STEEL FRAMING



SPECIFICATIONS

UNIT TYPE	WIDTH	HEIGHT	MAX. BTU (NG)	MIN. BTU (NG)	MAX. BTU (LP)	MIN. BTU (LP)	VENTING
New York View 40	40"	15"	28,900	15,500	28,900	15,500	4" x 6-5/8"
New York View 72	72"	15"	44,000	23,500	31,500	25,000	5" x 8"
Chicago Left Corner 40	44"	15"	28,900	15,500	28,900	15,500	4" x 6-5/8"
Chicago Right Corner 40	44"	15"	28,900	15,500	28,900	15,500	4" x 6-5/8"
San Francisco Bay 40	48.5"	15"	28,900	15,500	28,900	15,500	4" x 6-5/8"

FEATURES

- Clean face design (no frames or silicone)
- Invisible glass safety barrier (patent pending)
- Cool touch wall technology (patent pending)
- Decorative rated
- Standard interior lighting
- Proflame II remote with 50% turndown
- Internal control system (no remote access door required)
- Optional steel framing kits
- Optional Heatwave kit
- No power or cooling vents required

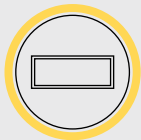

No Frame Clean Face Design

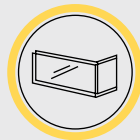

Invisible Glass Safety Barrier



Cool Touch Wall Technology



Proflame II Remote



Standard Interior Lighting

SPECS & DRAWINGS

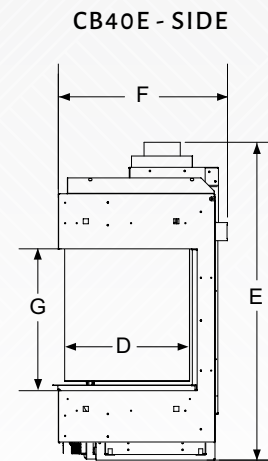
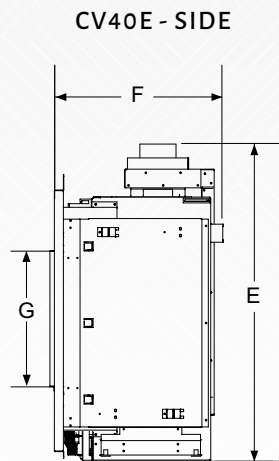
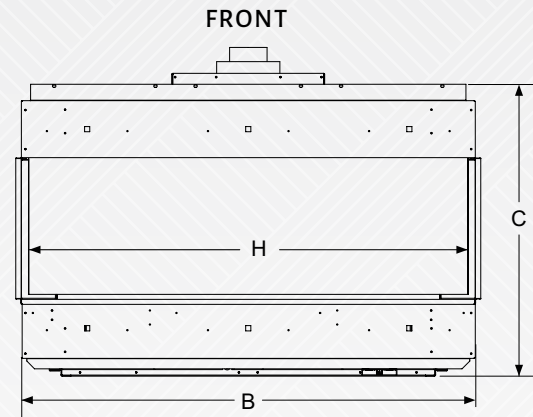
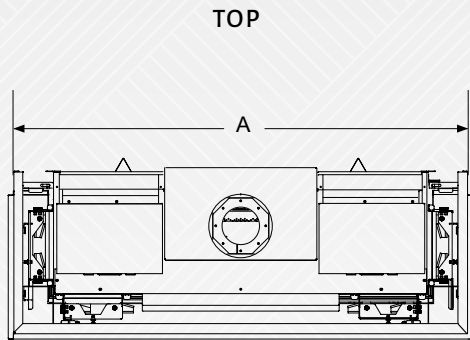

UNIT TYPE	A	B	C	D	E	F	G	H
New York View 40 - CV40E	43-9/16"	43"	34"	-	37-3/8"	18-11/16"	15-1/16"	38-13/16"
San Francisco Bay 40 - CB40E	48-7/16"	49-5/8"	34"	11-7/16"	37-3/8"	18-11/16"	15-1/16"	47"

For installation, framing and clearances refer to manuals on our website: www.regency-fire.com

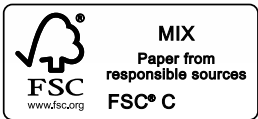

© 2016 FPI Fireplace Products International Ltd. Regency, Regency Horizon, SureFire, Heat Wave, Heat Release, AstroCap, are registered or proprietary trademarks of FPI Fireplace Products International Ltd. All rights reserved. Printed in Canada (07/16)
Part No. 944-427

WWW.REGENCY-FIRE.COM

Your Regency Dealer